

Introduction to

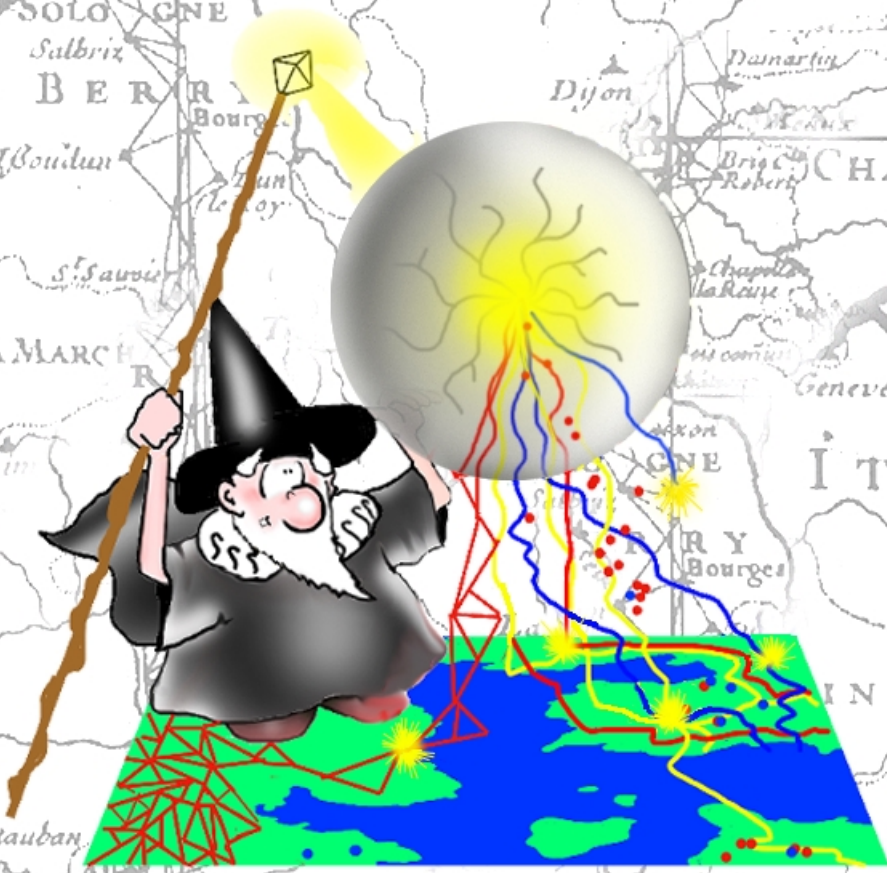

GIS



with
TNTmips®

TNTedit™ and **TNTview®**

Before Getting Started

TNTmips[®], TNTview[®], and TNTedit[™] all offer a wide variety of tools for those working in the many fields that make use of Geographic Information Systems (GIS). The purpose of this booklet is to acquaint you with the concepts and tools required for the management and analysis of spatial data, which is the primary focus of GIS. All of the features required for a robust GIS system are available in TNTmips, which is used to demonstrate some of the tools and concepts described throughout this book.

Prerequisite Skills This booklet assumes you have completed the exercises in *Getting Started: Displaying Geospatial Data* and *Getting Started: Navigating*. Those exercises introduce essential skills and basic techniques that are not covered again here. Please consult these booklets for any review you need.

Sample Data This booklet does not use exercises with specific sample data to develop the topics presented in this booklet. You can, however, use the sample data distributed with the TNT products to explore the ideas discussed on these pages. If you do not have access to a TNT products CD, you can download the data from MicroImages' web site. Make a read-write copy on your hard drive of data sets you want to use so changes can be saved.

More Documentation This booklet is intended only as an introduction to the GIS functions in TNTmips, TNTedit, and TNTview. Consult the TNTmips reference manual and booklets in the *Getting Started* series for more information.

TNTmips and TNTlite[®] TNTmips comes in two versions: the professional version and the free TNTlite version. This booklet refers to both versions as "TNTmips." If you did not purchase the professional version (which requires a software license key), TNTmips operates in TNTlite mode, which limits the size of your project materials and enables data sharing only with other copies of TNTlite. All of the GIS processes described in this booklet can be performed in TNTlite.

Merri P. Skrdla, Ph.D., 22 August 2000

It may be difficult to identify the important points in some illustrations without a color copy of this booklet. You can print or read this booklet in color from MicroImages' web site. The web site is also your source of the newest Getting Started booklets on other topics. You can download an installation guide, sample data, and the latest version of TNTlite.

<http://www.microimages.com>

An Introduction to GIS

Geographic Information Systems (GIS) is an evolving, catchall phrase that initially referred to management of information with a geographic component primarily stored in vector form with associated attributes. This definition quickly became too restrictive with advances in software and ideas about information management. An advanced GIS system should be able to handle any spatial data, not just data tied to the ground by geographic reference points. The capacity to handle non-geographic spatial data was formerly the domain of systems referred to as AM/FM (Automated Mapping and Facilities Management). Other non-geographic applications, such as interactive medical encyclopedias that retrieve information based on the human form, should also be manageable by a robust system.

Integration of imagery with vector data is now a necessity for a full-featured GIS system. Imagery was once thought to be the exclusive domain of image processing systems, but is now often required as a backdrop for vector, or other data, types.

No up-to-date GIS system is complete without surface modeling and 3D (technically 2 1/2 D) visualization with “fly-by” capability. In addition to drawing a path for the simulation, you should be able to orbit with the view directed at a specified point or have the view pan around a stationary viewer. Vector overlay on this 3D surface should also be an integral part of the package.

A GIS system should be production oriented, which may or may not mean product oriented. Production work in GIS involves making maps (a product), but it also involves interactive analysis (a result which may have no tangible product). This booklet starts by looking at these two aspects of GIS systems and then describes the facets of GIS systems needed to reach the integrated goals.

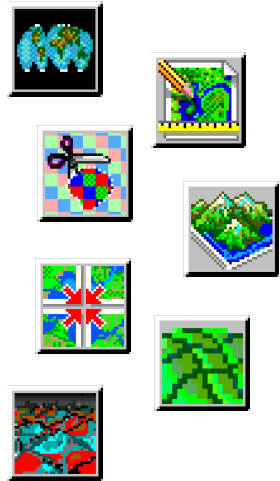

Pages 4–5 introduce the potential of GIS systems. The different object types used in managing spatial data are described on pages 6–13. Subsequent pages discuss other processes used in GIS systems, such as region and vector combinations, and additional features for the already described object types, such as theme mapping and legends.

Making Maps and Posters



A map is...

GIS map making should transcend traditional cartography—roads, streams, and political boundaries along with map grids, scale bars, and legends may be sufficient for some maps but are not an adequate reflection of a fully featured GIS system. You should be able to incorporate a satellite or airphoto image as the background for line and polygon data with transparent polygon filling to reveal the background through vector or CAD overlays. You should be able to incorporate enlarged insets and elements that tie the components at both map scales together.

...built from...

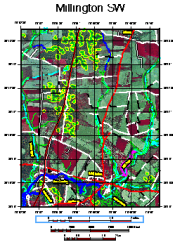

...many pieces.

To make map making easy, a GIS system should include a variety of standard map components that can be readily added to a layout. These include map grids, scale bars, legends, annotation text, and a means of mixing georeferenced and ungeoreferenced groups (north arrows, company logos) to complete the map. Each of these map components should be easily customizable; for example, with map grids you should be able to control the size and color of the text and lines, the grid spacing, the components of the grid, and so on.

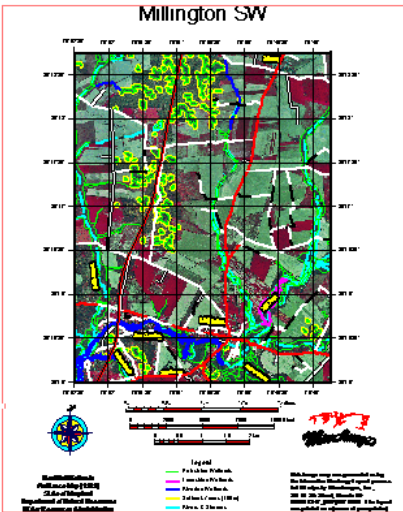
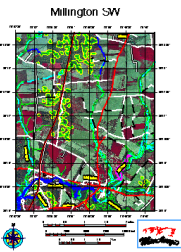

Maps can take a variety of forms.

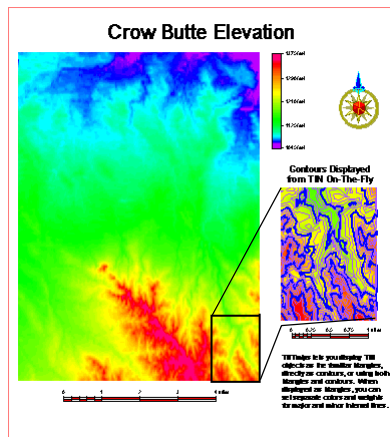

Interactive GIS

Another important aspect of a GIS system is the association of attributes with elements and the ability to select elements and view their attributes and to use attributes to select elements. You should also be able to quickly identify elements that have no attributes attached and elements with multiple attribute records attached.

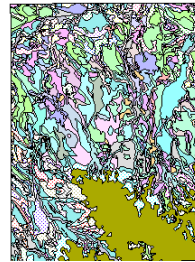

use attributes to assign style

Attributes should be dynamic so that new values can be calculated on-the-fly from values in other fields or other tables. Such computed fields are then updated whenever the fields used in their calculation are updated. If values for a computed field will not change once calculated, there should be a means to make values permanent. Attributes should also be useful for theme mapping and be available for direct display (pin mapping) provided each record includes spatial coordinates.

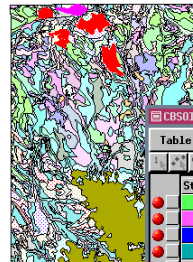

select polygons; view attributes

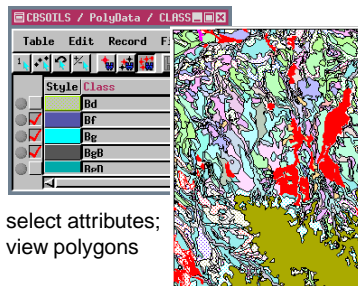

select attributes; view polygons

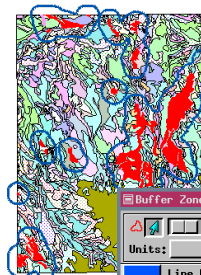

Generate buffer zones around selected polygons.

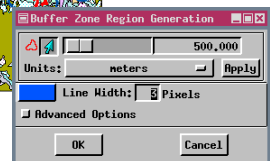

Buffer zones used to extract rivers within 500 m (in red) of the selected soil types. Attributes for one of the extracted lines (magenta) are shown.

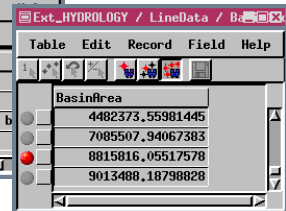
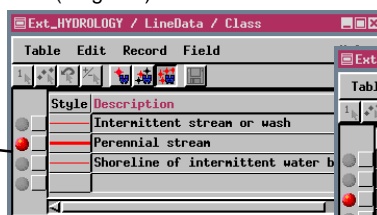
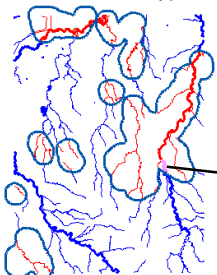

Raster Objects

8-bit composite color raster object (unsigned)



cell values

97	88	97	97	97	88	88	88	84	80	80	88
88	127	97	21	97	224	97	97	84	127	84	88
88	127	97	97	21	224	224	97	97	97	84	84
84	127	68	84	84	84	88	97	136	97	97	127
71	140	140	113	109	121	121	84	88	97	97	88
123	182	63	172	99	99	99	71	88	136	136	21
182	182	99	99	99	99	123	97	97	81	65	84
99	63	99	172	99	99	226	71	21	81	207	75
99	63	63	153	99	99	99	71	136	142	81	81
99	63	153	182	99	99	99	92	136	72	81	81

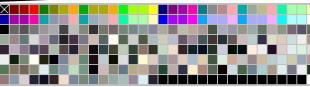

color map

A raster is a two-dimensional array of numbers that results in a screen image. Each array position defined by a line and column number is called a "cell." Cell values can be of many types ranging from 1-bit (binary) to 128-bit (complex numbers). In between these extremes are signed and unsigned integer data from 8- to 32-bit, 16- to 64-bit floating point, and 16- and 24-bit composite color rasters. Your GIS system should display all these data types regardless of your display's pixel depth, and color images should be generated from composite color rasters (8-, 16-, and 24-bit), color map application (8- and 16-bit), and multiple component raster display.

Multiple raster components used to produce a color-infrared image (photo-infrared as the red display component, red as green, and green as blue). Contrast was applied to each component before the color image was derived.

Raster values are often modified or interpreted from the original values by application of contrast tables, color maps, or both before producing a screen image. The ability to alter display characteristics without altering original data values is essential for meaningful image processing and analysis.

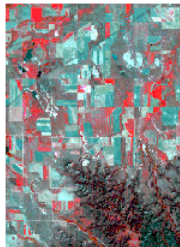
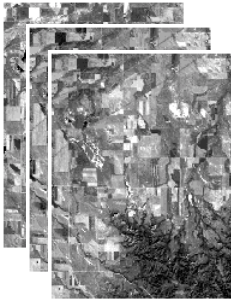

The size of raster that can be accommodated and the speed of display for large rasters is often as important an issue as the data types supported. TNT professional products support all the data types described in raster objects as large as four terabytes*. Sampled display of the full image of such a large raster can be achieved in just a few seconds in the TNT products.

* A terabyte is 1000 gigabytes.

Cell values can represent either continuous or categorical data. The continuous red, green, and blue bands (left) of an airphoto can produce a color image (center) or be automatically classified to create a categorical raster (right).

The size of raster that can be accommodated and the speed of display for large rasters is often as important an issue as the data types supported. TNT professional products support all the data types described in raster objects as large as four terabytes*. Sampled display of the full image of such a large raster can be achieved in just a few seconds in the TNT products.



Coordinate Data Objects

Coordinate data objects use XY or XYZ coordinates to describe the elements in an object. Coordinate data objects include vector, CAD (Computer Aided Design), and TIN (Triangulated Irregular Network) formats. These coordinates may directly represent geographic position (decimal degrees or UTM in meters, for example) or may be derived from screen, raster, digitizer, or other arbitrary coordinates.

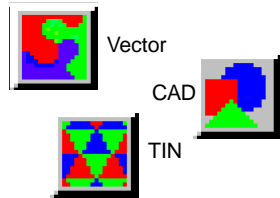

Coordinate data objects are made up of specific element types commensurate with the data format. Each of these element types can also have associated attributes stored in database form. Each of these coordinate data types is best suited to particular applications. Vector data is necessary for applications that require ground area to be included in one polygon only, such as land ownership maps. CAD objects are best suited for architectural drawings and other applications requiring geometric shapes or repetition of groups of elements (blocks). TIN objects are best suited for compact representation of 3D surfaces. Additional features of these data types will be described in the next few pages.

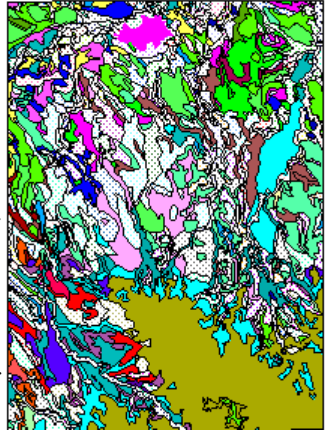

This vector contains 1504 nodes (not drawn), 2237 lines (all same in black), and 777 polygons (filled solidly or with bitmap or hatch patterns).

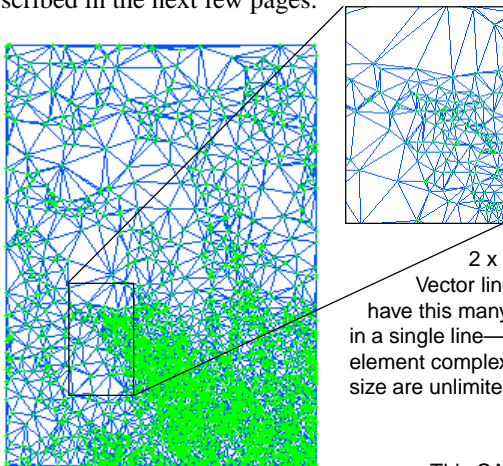

This TIN contains 3725 nodes, 11144 edges, and 7420 triangles.

All coordinate data objects in TNTmips can have more than 2×10^9 elements.

Vector lines can have this many vertices in a single line—in essence element complexity and object size are unlimited.

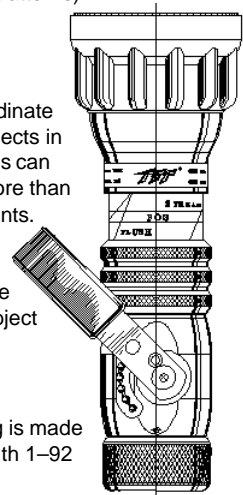

This CAD drawing is made up of 43 blocks with 1–92 elements in each.

Vector Objects

contours (isolines)

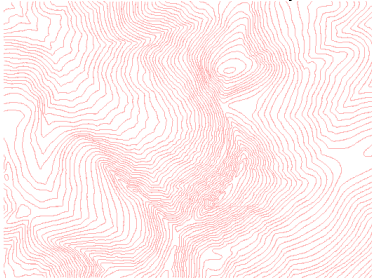

roads, hydrology, and point features in a rural area.

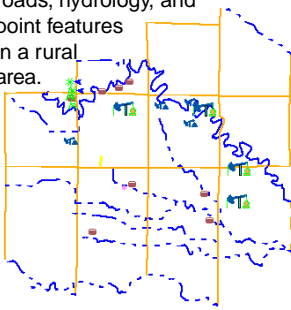

soil type polygons

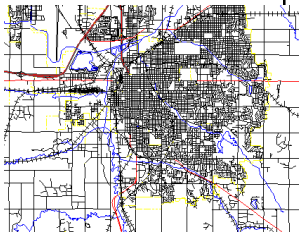
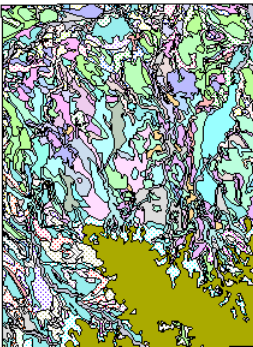

Vector objects may include nodes, points, lines, polygons, and labels. Strict topological vectors are an absolute must for a GIS system. Strict, or polygonal, topology requires that no two nodes have the same X and Y coordinates, all lines start and end in nodes, lines do not intersect other lines or themselves (nodes are inserted where lines would otherwise cross), enclosed areas are defined as polygons, and any point can be in at most one polygon. When these stringent requirements are met, other vector topologies can be considered to reduce overhead requirements as discussed on the following page.

Another requirement of a GIS system is association of attributes with vector elements. Maintaining these attributes in relational databases associated with the vector elements simplifies attribute management. Once you have associated attributes, you need to be able to assign drawing styles to reflect the attributes. Ideally you can choose from a selection of symbols for points, patterns for lines, and bitmap and hatch patterns for polygon filling, and design your own if you don't find the style you want. You should also be able to create permanent labels or generate them on-the-fly.

The number and complexity of elements that can be included in a vector object may also be an issue. For example, ARC/INFO Coverage limits the number of vertices in a line to 500, which is many fewer vertices than in some of the contour lines in the object illustrated on this page.

TIGER data in urban (left) and rural areas.

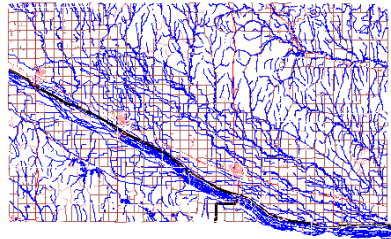

Topology Types

Polygonal topology, which is described on the previous page, is necessary if you want ground measurements, but it takes time and rigor to maintain. Other topology types, such as planar and network topology, require fewer system resources to maintain and are adequate or even better suited for applications not requiring ground area measurements.

Planar topology requires that all lines start and end in nodes and no two lines cross, as with polygonal objects, however, polygon information is not maintained. Planar and polygonal vectors appear the same except polygon filling is not available for planar vectors because there are no polygons. Planar topology may be appropriate for hydrology if no lakes are present or for road systems that lack overpasses, underpasses, and other features that require network topology for correct representation.

Polygonal and planar topology can be either 2D or 3D, but topology is maintained in the X-Y plane for 3D objects of these topology types, which means that nodes separating lines that would otherwise cross are determined by projection onto the X-Y plane. Such lines may not actually intersect in three dimensions and would be better represented using network topology.

Network topology places nodes at the start and end of all lines, but lines may cross themselves or other lines. As with planar topology, there are no polygons. Note the absence of nodes where lines cross in the grid at the right. Although nodes need not occur where lines cross, they can be present at any intersection and are necessary for use in network analysis (routing and allocation). The constraints imposed by 2D topology on 3D objects are eliminated by choosing network topology, which allows two nodes to have the same X and Y coordinates. Lines that appear to cross in a planimetric view may be separated in 3D by their Z values (lower right).

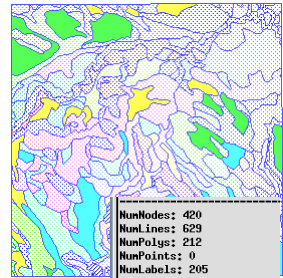

Polygonal
Topology

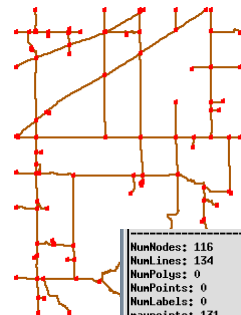

Planar
Topology

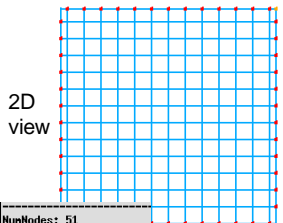

2D
view

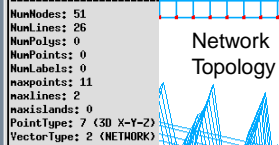

Network
Topology

3D
view, same object

CAD Objects

N X 1
text element



X 4
block insertion
made from
triangular
polygons



X 4
block insertion
made from
triangular
polygons

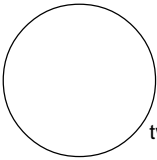

X 5
three filled
circles and
two outlines

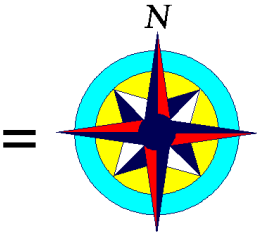

=
elements displayed using
attributes to assign style

CAD objects have free-form topology; they are made up of elements that retain their own shape regardless of the relative position or changes to other elements. The elements in a CAD object may overlap one another and have a defined drawing order, which may be changed, that determines which elements appear to be on top. CAD elements include points, lines, polygons, text, and a variety of geometric shapes. The geometric shapes are defined by center points, radii, and angles. These characteristics are maintained after elements are added, regardless of the other elements in the object, and can be modified in later editing sessions. Unlike a vector polygon created with the circle tool, a CAD circle can be resized by changing its radius or moved by changing the location of its center point.

CAD elements include points, lines, polygons, regular polygons, boxes, circles, arcs, arc chords, arc wedges, ellipses, and text. Individual CAD elements can be organized into blocks that are inserted at one or many positions within a single drawing or used throughout a series of drawings. The short and long direction points in the North arrow at the left are each blocks made up of polygons. Polygons and other closed shapes can be filled with solid color or a fill pattern. The outline can be omitted, be a solid color, or be a line pattern.

Other examples of CAD objects shown below include structural drawings and additional North arrows.

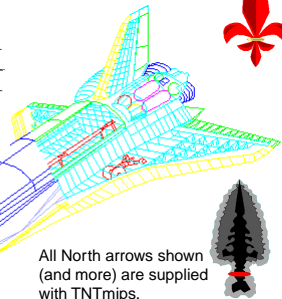
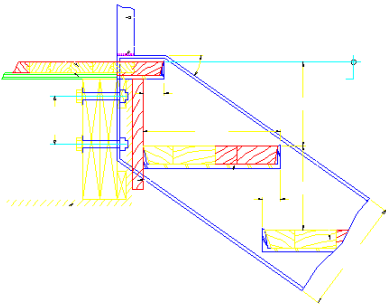

All North arrows shown
(and more) are supplied
with TNTmips.

TIN Objects

TINs (Triangulated Irregular Networks) are composed of nodes, edges, and triangles. The nodes are irregularly spaced three-dimensional points, connected by edges to represent a surface as a set of adjacent, conterminous triangles constructed so that every triangle satisfies the Delaunay criterion. Delaunay triangulation requires that triangles constructed from a randomly dispersed set of points are as small and equilateral as possible. Choosing points for a triangle is an arbitrary process; results are unique; from a set of points there is only one set of triangles that meet the Delaunay criterion.

TINs are one of three formats commonly used to represent functional surfaces, such as the Earth's surface. [The other two are Digital Elevation Models (DEMs) and contour maps.] The TIN data structure minimizes the number of points needed to accurately represent surface variations.

TINs can be represented directly as contours, either alone or in combination with nodes, edges, and / or triangles. The standard attributes calculated for TIN objects include slope and aspect, which can be used to shade the triangles so these attributes are readily conveyed even in 2D representations.

When standard attributes are generated for a TIN object, slope and aspect are calculated for each triangle (in addition to area, perimeter, and center coordinates). These attributes can be used to determine fill colors for the triangles that convey a good deal about the topography even in a 2D view (below).

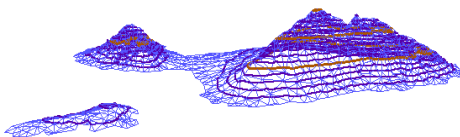

A TIN object shown in 3D perspective view with overlaid contours generated on-the-fly (above) and the contours alone (below). The 2D view of the same TIN (right) shows the triangles filled with a color assigned by a script that uses the slope and aspect of the triangles to determine the color.

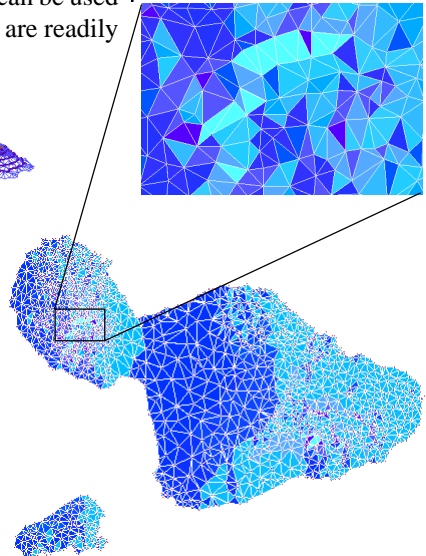
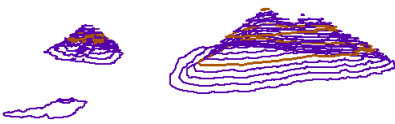

Making Pin Maps

Pin mapping should provide a means to distinguish multiple pins with the same coordinates, such as the pins shown below for the same sites in three different years. Symbol scale can also vary with field values.

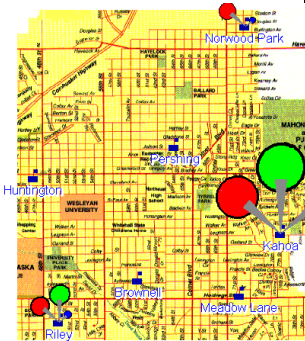

You should also be able to include values for multiple fields from the same record. The TNT products let you choose between bar graphs or pie charts with the option of including multiple line labels.

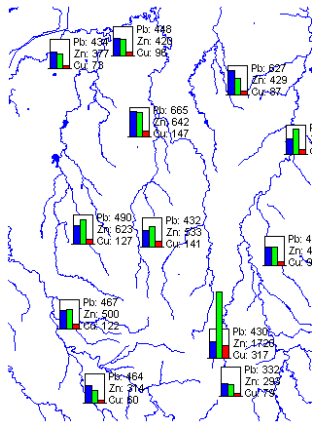

A pin map directly visualizes database information if each record has coordinates for the location of the observation or report. You could plot telemetry data for a variety of animals, the location of cities, or the position of trucks on the road. Direct display from database offers some advantages over vector format for point data. New points are added simply by adding records to the database and the location of points can be updated by changing coordinates.

In TNTmips databases used for pinmap display can be in internal format, linked to a supported format (such as dBASE IV, INFO, or FoxPro), or communicated with using ODBC (Open Database Connectivity to Oracle, for example). With direct linking or ODBC, the database can be maintained by external software and viewed with all updates available the next time you redraw the pinmap.

You can display all locations in the same style or use other attributes to determine how a “pin” is displayed. For example, you can use production to determine the size of symbols for oil wells or, in the case of telemetry data, you can represent observations for different animals with different symbols. You can even incorporate multiple attributes into a pie chart or bar graph.

The same records shown as a bar graph (left) and a pie chart with different background layers. The bar graph includes labels for each of the fields graphed.

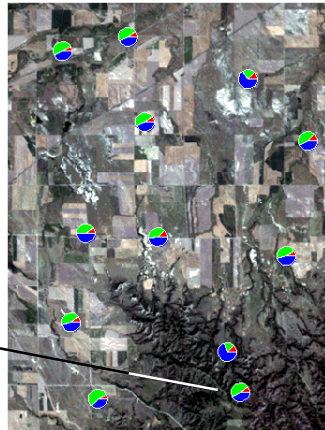

Attribute Databases

Attribute databases keep track of information associated with coordinate data elements, such as a polygon's soil class, the road type of a line, or the identity of a point. These kinds of attributes are generally primary keys, which can be used for styling by attribute. Other attributes, such as population of a city or crop yield of a polygon, can be used for theme mapping or styling by query. You should be able to calculate new information from values in existing fields, such as population density from population and area fields or the percentage of the population in the four largest cities as shown at the right. String fields can also be concatenated if desired.

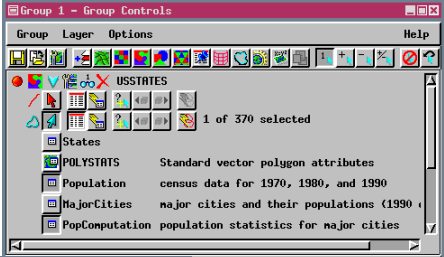

Attribute databases can also be associated with raster objects by cell value, which may be useful for rasters created by interpretive processes, such as Feature Mapping and Automatic Classification.

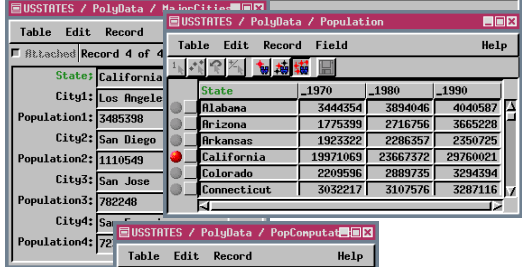

You can select elements and view their associated attributes or choose attributes and highlight the elements that have them. You can query the database to select elements with particular attribute values.

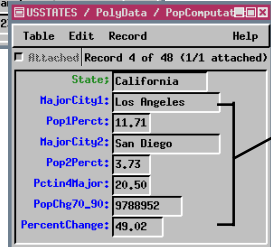

All of these fields are "computed," which means they are derived from values in other tables.

This query selects all state polygons with population greater than 3 million in 1990. The number of polygons selected (reported at bottom of query window) is much larger than the number of states because most coastal states have islands offshore.

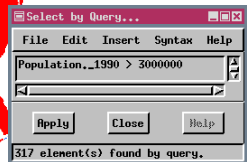
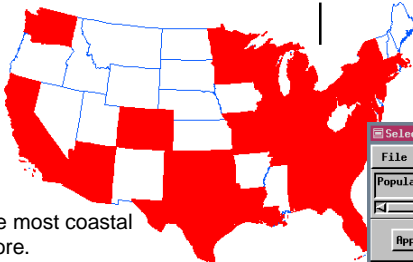

Using Regions

Use the line drawing tool or a selected line to evaluate a potential dam site.

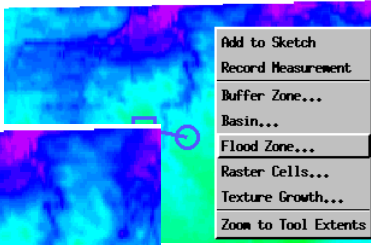

Regions are areas of interest used primarily for selection—selection for viewing attributes, for extracting, or for other processing. In some cases, such as flood zone or watershed regions, the region itself is the desired product.

The region can delimit either the potential lake area behind a dam of specified height (above) or the area that would flood if the dam broke (right).

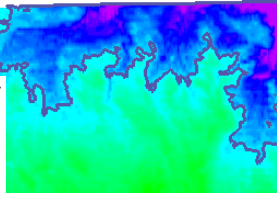

Regions can be interactively and iteratively created. You choose the cells or elements of interest, then the desired region creation process, adjust region

parameters, generate a region, alter parameters as necessary and generate another region until you are satisfied with the results and choose to keep that region. Regions can be temporary, available only for the current display session, or you can choose to save a region to be used at a later time or in other processes.

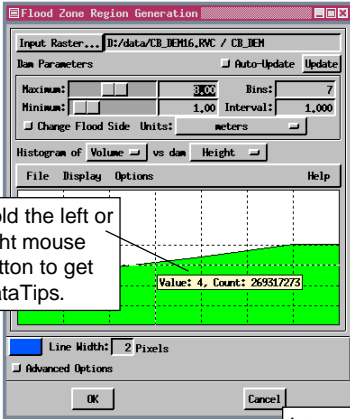

Region generation methods available in TNTmips and not mentioned elsewhere on this page include selected polygons, buffer zones, viewshed, Voronoi regions, raster texture growth, and cell values.

Internal.ElemNum <= 54 or Internal.ElemNum >= 144

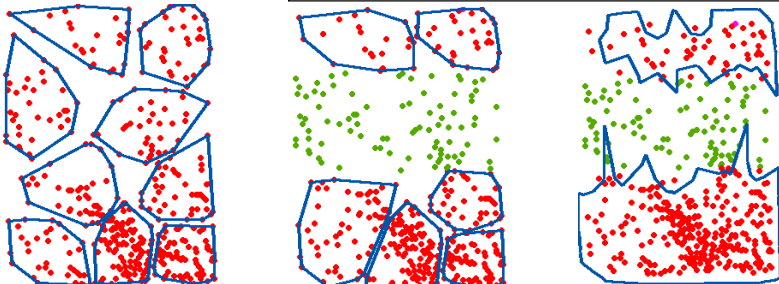

K Means cluster regions with all (left) or query selected points (middle) and the region formed by Polygon Fitting (Tessellation, right) with the same query selected elements.

Generating Buffer Zones

Generation of buffer zones can be much more sophisticated than the simplistic one buffer distance for selected elements available for regions. You can elect to buffer all lines or lines selected from the screen or by attribute, as is the case when creating buffer zone regions. Additionally, when making vector buffer zones, you can assign different buffer distances by attribute values and choose whether to maintain separate buffer zones by attribute or merge buffer zones that intersect. The attributes of elements buffered can also be transferred to the resulting buffer zone vector polygons (regions do not have associated attributes).

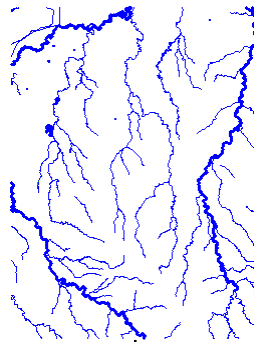

Hydrology with lines classified as intermittent (thin) or perennial (wide) streams or shorelines.

Buffer Zone Analysis

Vector... | D:\DATA\va0_rvc / HYDROLOGY

Pointat: None | Select...

Lines: By Attribute | Select...

Polygons: All | Select...

Distance: 200,0000

Distance Unit: meters

Polygon Side: Exterior | Reset

Save Islands Attribute Control...

You can choose to buffer any or all of the element types in a vector object. If you want buffer zones to be separated by the attributes of the buffered elements, only one element type can be selected.

Buffer zone **region** generated at 200 meters from selected lines (also shown).

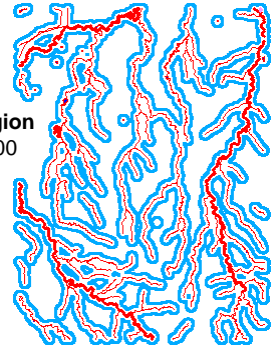

Select Field Values

Key Field: Description

Value: 400,0000

+	200,0000	Intermittent stream
+	400,0000	Perennial stream
+	200,0000	Shoreline of intern
+	400,0000	Shoreline of perenn

The setback distance can be designated separately for each attribute value. Here, a buffer distance of 200 meters is specified for intermittent water features and 400 meters for perennial features.

Buffer polygons merged (left, default) or separated by attribute (below, right).

Attribute Control

Reassign Points

Reassign Lines

Reassign Polygons

Separate By Attributes

Lines | Select...

Key Field: Description

Accept Cancel Help

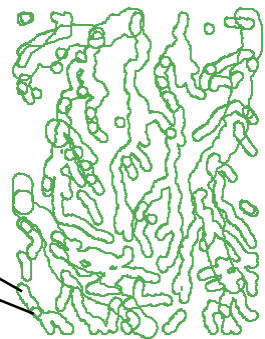
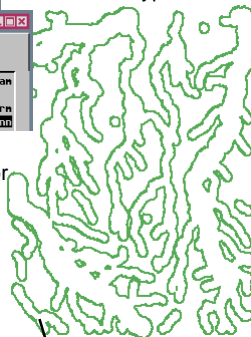

This buffer zone polygon was created by buffering both an intermittent stream and the shoreline of an intermittent water body, so both attributes are attached.

BUFFVECT1 / PolyData / Class

Description
Intermittent stream or wash
Perennial stream
Shoreline of intermittent wat
Shoreline of perennial water

Region and Vector Combinations

Vector combinations also allow you to restrict the element set used in the combination by attribute, by query, or by direct selection. By selecting which polygons to use in a vector combination, you can either include or exclude islands in the equation.

Many vector combinations are “cookie cutter” operations, such as the one shown, which is not an option in region combinations. Regions, however, can be used as cookie cutters on vectors directly in the display process.

Region and vector combinations let you combine objects mathematically by georeference. Combination by geographic extent is a very powerful feature that allows input with different scales and map projections, which are resolved on-the-fly to create the output object.

The three major differences between combining vectors and combining regions are that region combination is accomplished interactively in the display process, vector combination preserves attributes from one or both of the input objects (regions do not have attributes), and many more combination options exist for vector objects.

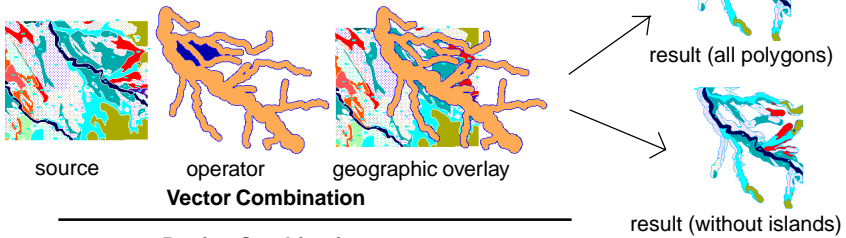

Region Combination

10 mile buffer around cities with population < 20,000

100 mile buffer around cities with population > 500,000

region within 10 miles of city < 20,000 and at least 100 miles from city > 500,000

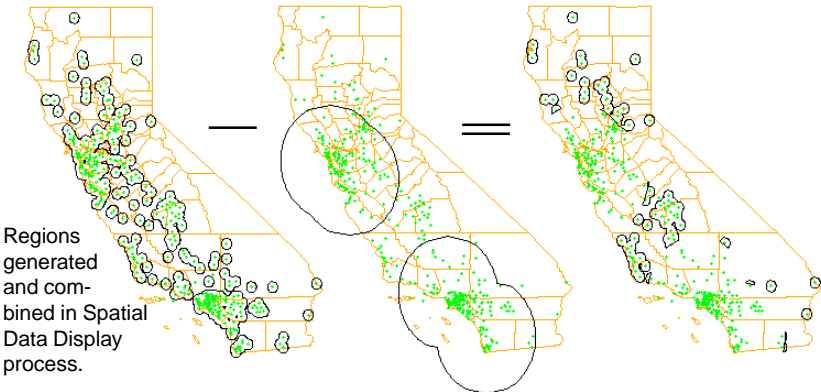

Making Measurements and Sketches

The ability to get real ground measurements from any georeferenced or scale calibrated object is an important aspect of any GIS system. A variety of tools for obtaining measurements is also important.

The most common measurements are probably from one location to another. TNTmips provides two tools, the ruler and line tools, so you can get either an “as the crow flies” or a complex path measurement. Arc and arc wedge tools provide protractor, or angular, measurements. A polygon tool lets you determine the area and perimeter of irregular shapes. A number of tools for measuring around regular shapes (rectangles, circles, ellipses, regular polygons) are also provided. A wide variety of units, which can be changed at any time, is available for measurement reports. Measurements can also be recorded in a text file.

The TNT products use these same tools for sketching so that you can create quick annotated layer interpretations. Since both the sketching and measuring tools are part of the GeoToolbox, you can view and record the size of each sketch element, if desired, before adding it to a sketch.

Use the ruler tool to measure the distance between two points, such as county road intersections.

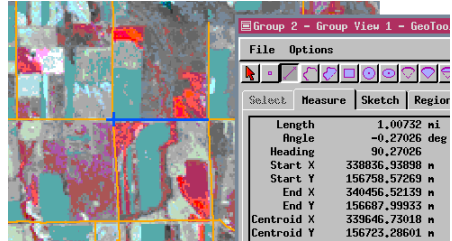

Use the arc or arc wedge tools to determine the angle between linear features.

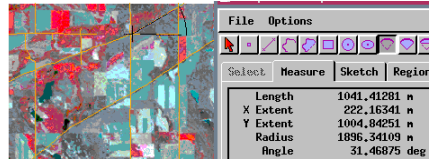

Use the polygon tool to measure irregular areas.

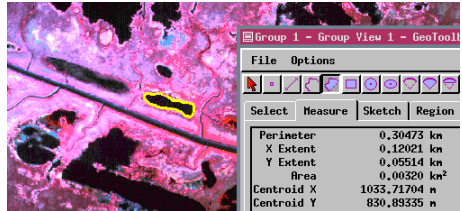

Measured areas can become sketch elements (right mouse button click) and annotated.

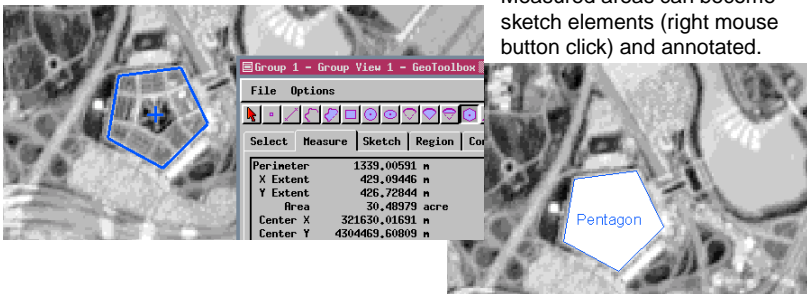

Making Theme Maps

Theme mapping is a powerful means to look at quantitative trends and classes of attributes associated with vector and TIN elements. Theme maps provide a ready means for visualization of this information without the need for you to design the scripts that identify the classes and assign meaningful styles. Theme mapping treats the values in a designated field statistically and assigns styles to the classes identified according to the parameters you specify.

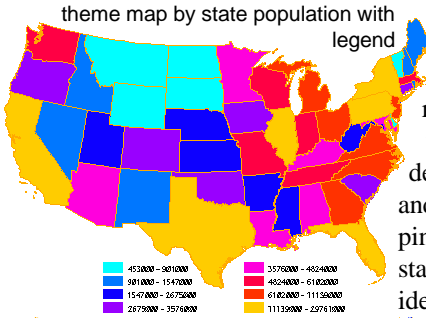

Theme maps provide a ready means for visualization of this information without the need for you to design the scripts that identify the classes and assign meaningful styles. Theme mapping treats the values in a designated field statistically and assigns styles to the classes identified according to the parameters you specify.

Themes can be created for point, line, and polygon elements. Themes are maintained using style assignment tables and style objects, just as when drawing style is assigned by attribute.

The same color scheme as above used with a variable color bitmap fill pattern. Using a bit map pattern gives a hint of the attribute being mapped and also lets you see through to any background imagery.

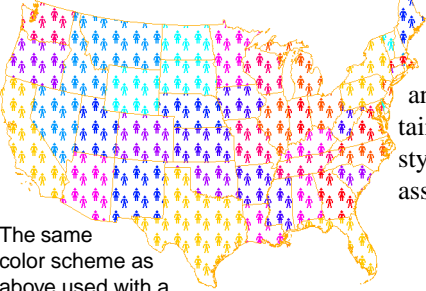

Choose between counting all records, records by reference, or by element size (line or polygon themes).

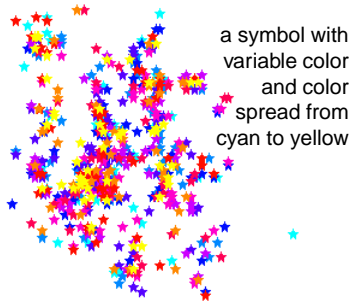

a symbol with variable color and color spread from cyan to yellow

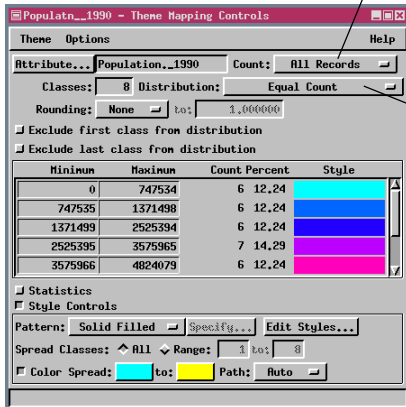

The distribution can be equal count, equal interval, or user-defined.

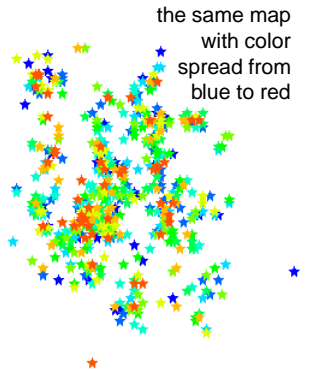

the same map with color spread from blue to red

Other Important Features

For meaningful visualization of geospatial data you should be able to display and print at specified map scales and control the visibility of layers in a layout by the map scale (layers/elements appear and disappear as you zoom in and out). Automatic legends that can be turned on and off for viewing are also an important feature. To make map making easy, a GIS system should include a variety of standard map components that can be easily added to a layout. These include map grids, scale bars, legends, annotation text, and a means of mixing georeferenced and ungeoreferenced groups (north arrows, company logos) to complete the map. Printing to a wide variety of printers, including printers not attached to a computer with the GIS software, is another important feature.

Once you have data in a GIS system, you need to be able to correct and update it. You also need a way to create and edit objects using any kind of data you already have as a reference. All new objects created should automatically acquire map registration from their reference objects so that they can not only be scaled and displayed with the original reference objects, but with any other georeferenced objects in any map projection.

One very important feature of an advanced GIS system is that it continues to evolve and incorporate new technologies. This evolution must maintain backward compatibility so that longtime clients don't have to start over when significant changes in file formats or features are introduced.

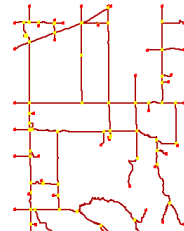

Vector needing update...

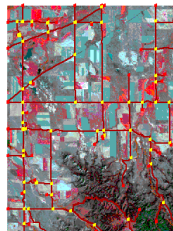

...overlaid on recent imagery for reference...

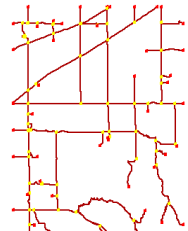

...and updated.

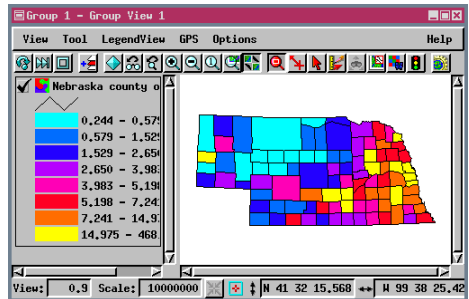

Theme map of county population density in Nebraska displayed at 1:10000000 with an automatic legend.

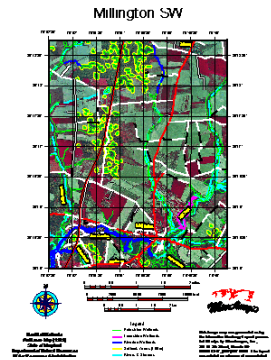

The ability to add map grids, scale bars and text, as well as to create legends, should be an integral part of the map layout process.

Advanced Software for Geospatial Analysis

MicroImages, Inc. publishes a complete line of professional software for advanced geospatial data visualization, analysis, and publishing. Contact us or visit our web site for detailed product information.

- TNTmips** TNTmips is a professional system for fully integrated GIS, image analysis, CAD, TIN, desktop cartography, and geospatial database management.
- TNTedit** TNTedit provides interactive tools to create, georeference, and edit vector, image, CAD, TIN, and relational database project materials in a wide variety of formats.
- TNTview** TNTview has the same powerful display features as TNTmips and is perfect for those who do not need the technical processing and preparation features of TNTmips.
- TNTatlas** TNTAtlas lets you publish and distribute your spatial project materials on CD-ROM at low cost. TNTAtlas CDs can be used on any popular computing platform.
- TNTserver** TNTserver lets you publish TNTAtlases on the Internet or on your intranet. Navigate through geodata atlases with your web browser and the TNTclient Java applet.
- TNTlite** TNTlite is a free version of TNTmips for students and professionals with small projects. You can download TNTlite from MicroImages' web site, or you can order TNTlite on CD-ROM with the current set of *Getting Started* booklets.

Index

annotation	17	multiple line labels	12
attribute databases	5, 13	network topology	9
bitmap fill patterns	18	ODBC	12
buffer zone regions	5, 15	pin mapping	12
CAD objects	10	planar topology	9
Cluster regions	14	Polygon Fitting regions	14
computed fields	13	polygonal topology	9
contours (isolines)	8	raster objects	6
coordinate data objects	7	region combinations	16
data types	6	sketching	17
flood zone regions	14	style by attribute	5, 13, 18
GeoToolbox	17	theme mapping	18, 19
interactive GIS	5	TIN objects	11
legends	4, 18, 19	vector buffer zones	15
map grids	4, 19	vector combinations	16
map layout	4, 19	vector editing	19
map scale	19	vector objects	8-9
measuring	17	vector topology	9



MicroImages, Inc.

11th Floor - Sharp Tower
206 South 13th Street
Lincoln, Nebraska 68508-2010 USA

Voice: (402)477-9554
FAX: (402)477-9559

email: info@microimages.com
Internet: www.microimages.com